

# SCHOCK



**RESI**  
513000



[www.schock.de/easy-resi](http://www.schock.de/easy-resi)





## PRODUKTMERKMALE PRODUCT SPECIFICATIONS



450  
17 3/4"

**Anschluss Schlauchlänge**  
Length of supply hoses



3/8"

**Gewindegröße Anschluss Schlauch**  
Thread size of supply hose



360°

**Schwenkbereich**  
Swivel range



**Flüsterperlator**  
Ultra-quiet aerator



3 bar ✓

**Wasserdruck**  
Water pressure



0,5 max 10

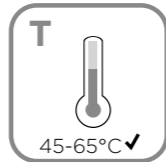

45-65°C ✓

**Temperatur**  
Temperature



°C max 80



3 bar 9l/Min ✓

**Wasserdurchlaufmenge**  
Water flow rate

l/min



## SICHERHEITSHINWEISE SAFETY NOTES

### SCHOCK

- DEU** DIE GEWÄHRLEISTUNG VERFÄLLT BEI LAIENMONTAGE. SCHOCK EMPFIEHLT DIE VERWENDUNG DES GROBPARTIKELFILTERS SF-100 (629883). KEINEN CHLORREINIGER VERWENDEN.
- ENG** THE WARRANTY IS VOIDED BY NON-PROFESSIONAL INSTALLATION. SCHOCK RECOMMENDS THE USE OF THE SF-100 (629883) COARSE PARTICLE FILTER. DO NOT USE CHLORINE-BASED CLEANING AGENTS.
- ES** LA GARANTÍA CADUCA CUANDO EL MONTAJE NO ES REALIZADO POR PERSONAL ESPECIALIZADO. SCHOCK RECOMIENDA LA INSTALACIÓN DEL FILTRO CONTRA PARTÍCULAS GRUESAS SF-100 (629883). SE ADVIERTE NO UTILIZAR DETERGENTES QUE CONTENGAN CLORO.
- TR** YETKİLİ KİŞİLERCE YAPILMAYAN MONTAJLARDA GARANTİ GEÇERSİZ SAYILACAKTIR. SCHOCK SF-100 (629883) KALIN PARÇACIK FİLTRESİNİ KULLANMANIZI ÖNERİR. ASLA KLORLU TEMİZLEYİCİLER KULLANMAYINIZ.
- POL** GWARANCJA TRACI WAŻNOŚĆ W PRZYPADKU NIEWŁAŚCIWEGO MONTAŻU. SCHOCK ZALECA UŻYCIĘ ZAWORU KĄTOWEGO Z FILTREM SF-100 (629883). NIE STOSOWAĆ ŚRODKÓW NA BAZIE CHLORU.
- RUS** ГАРАНТИЯ РАСПРОСТРАНЯЕТСЯ НА СМЕСИТЕЛИ УСТАНОВЛЕННЫЕ КВАЛИФИЦИРОВАННЫМ САНТЕХНИКОМ. SCHOCK РЕКОМЕНДУЕТ ИСПОЛЬЗОВАТЬ ФИЛЬТР ГРУБОЙ ОЧИСТКИ SF-100 (629883). НЕ ИСПОЛЬЗОВАТЬ ХЛОРСОДЕРЖАЩИЕ ЧИСТЯЩИЕ СРЕДСТВА.





## INSTALLATION INSTALLATION

3

**Anschlusschläuche an Eckventile anschrauben**  
Screw supply hoses onto angle valves

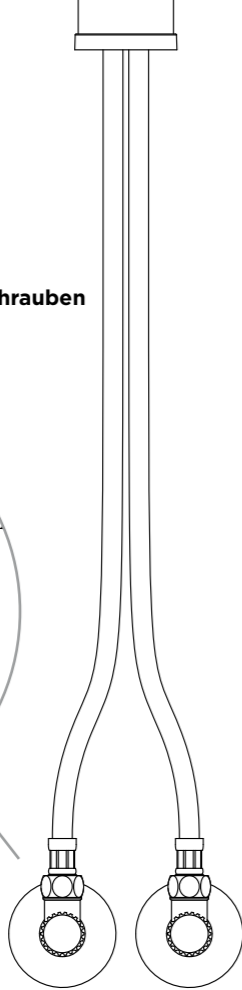
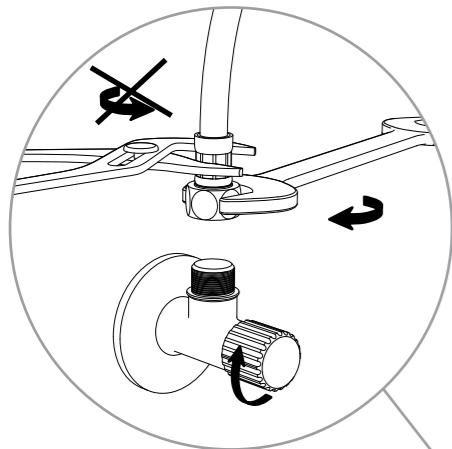

4

**Hebel öffnen und Perlator ausbauen um potenzielle Verunreinigungen auszuspülen**  
Open the handle and remove the aerator to flush potential dirt

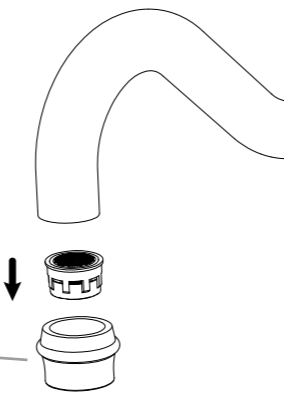
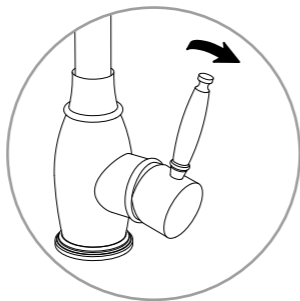

5

**Eckventile öffnen und alle Verbindungen auf Undichtheiten prüfen**  
Turn on water supplies and check connections for leaks

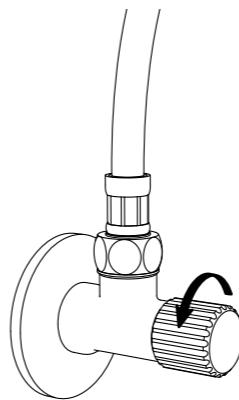

6

**Hebel schließen und Perlator wieder einbauen**  
Close the handle and re-install the aerator

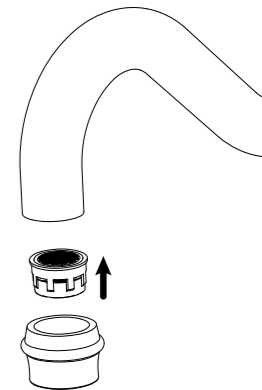
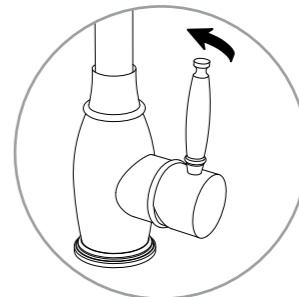

## SCHOCK

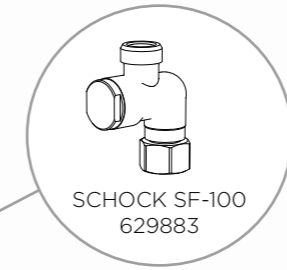
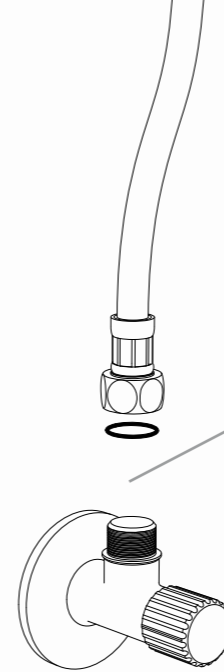

# BODYGUARD

**SF-100**

Auch in modernen Leitungssystemen werden im Wasser Sandkörner transportiert. Der SF-100 Grobpartikelfilter schützt die Kartusche und den Perlator einer hochwertigen Schock Armatur vor Beschädigungen.

Even modern plumbing systems transport grains of sand along with the water. The SF-100 coarse particle filter protects the cartridge and aerator in a premium Schock tap against damage.

[WWW.SCHOCK.DE/SF100](http://WWW.SCHOCK.DE/SF100)



**PFLEGEPRODUKTE**  
CARE PRODUCTS

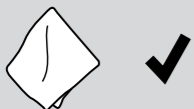
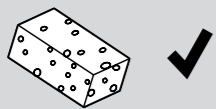

**PFLEGEHINWEISE**  
CARE INSTRUCTIONS

1.

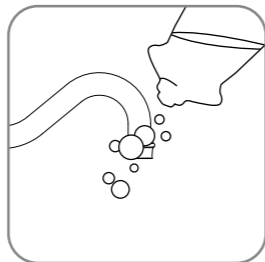

2.

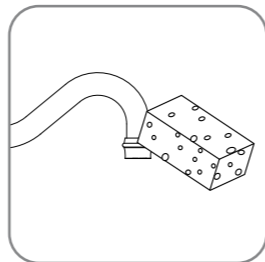

3.

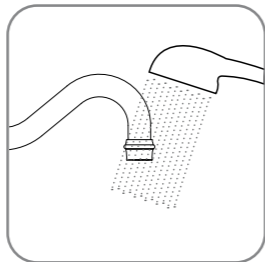

4.

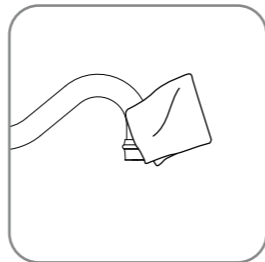

**WERKZEUGE**  
TOOLS

Kein Werkzeug benötigt  
No tools needed



**PERLATORREINIGUNG**  
CLEANING THE AERATOR

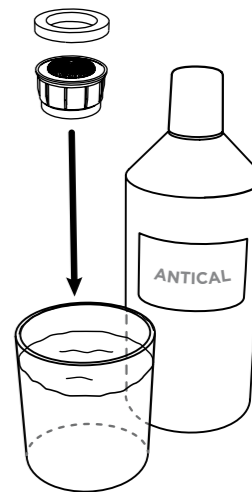
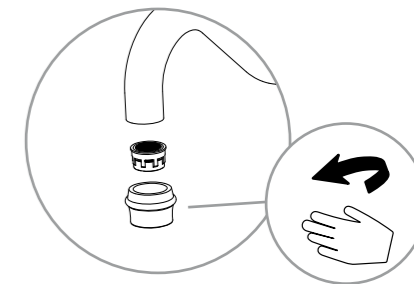

60 min



**WERKZEUGE**  
TOOLS

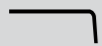

3 mm



29 mm



**KARTUSCHENWECHSEL**  
CHANGING THE CARTRIDGE

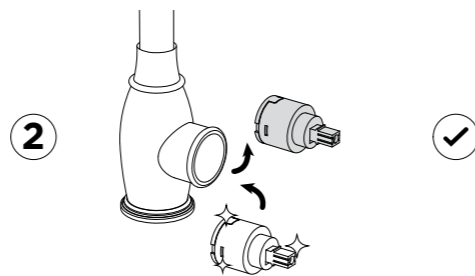
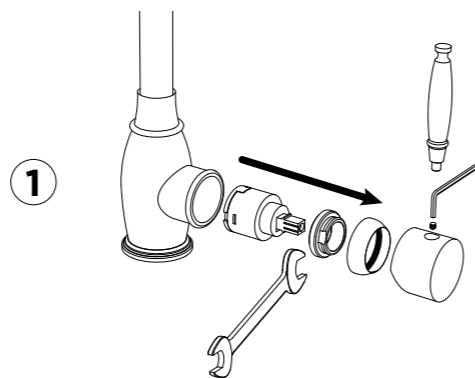

**SCHOCK**



**WEBSHOP**



[WWW.SCHOCK.DE/SHOP](http://WWW.SCHOCK.DE/SHOP)



## ERSATZTEILE SPARE PARTS

1 628778/1

2 628748/2

3 628778/2

4 628796XXX

5 628740/5

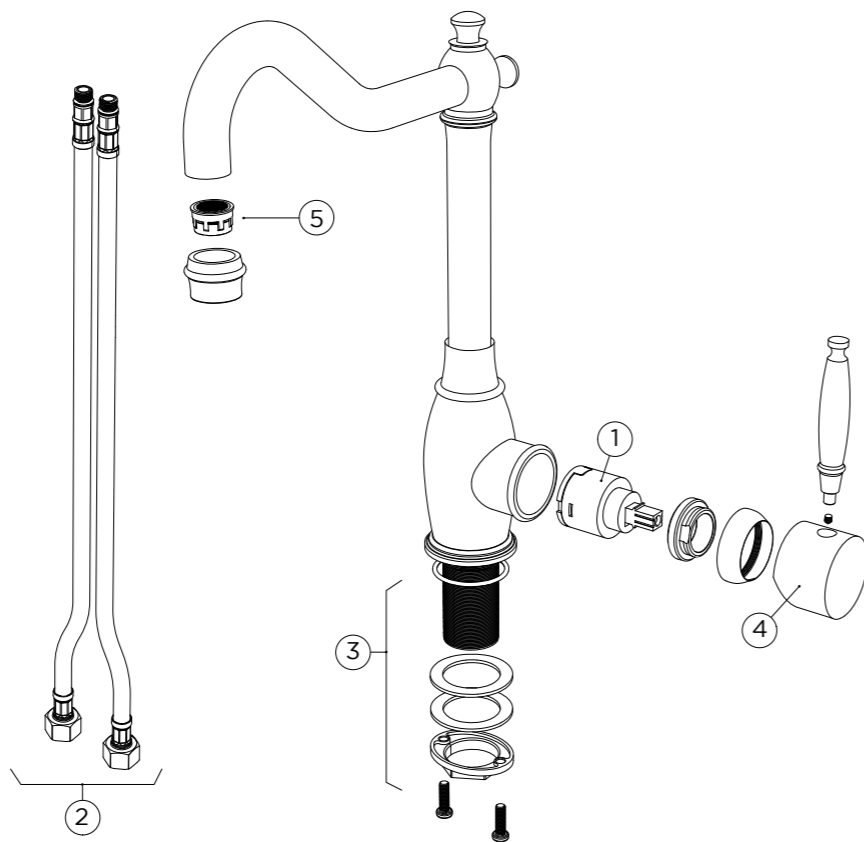

## MASSE MEASUREMENTS

## SCHOCK

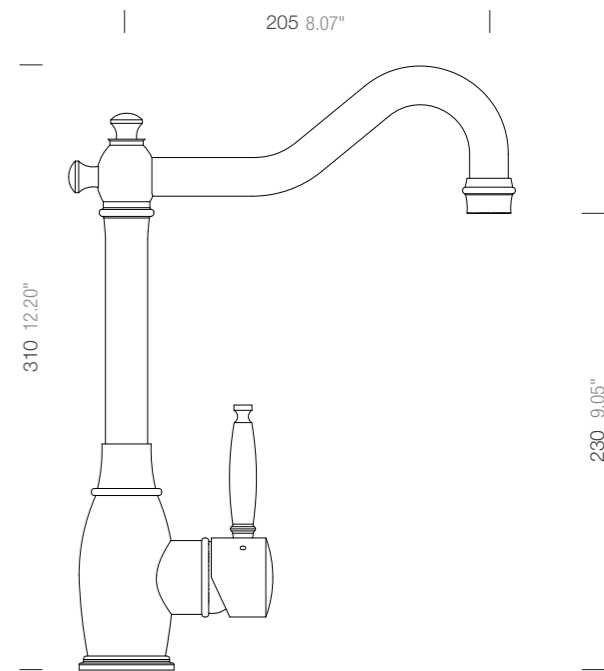





[www.schock.de/service](http://www.schock.de/service)



[www.schock.de/shop](http://www.schock.de/shop)

SCHOCK GmbH • Hofbauerstr. 1 • D-94209 Regen  
Telefon: +49-9921-600-0 • Fax: +49-9921-600-253

Email: [info@schock.de](mailto:info@schock.de) • [www.schock.de](http://www.schock.de)